

SPLIT TYPE ROOM AIR CONDITIONER

OPERATION MANUAL

HSU-07RS03/R2

HSU-09RS03/R2

HSU-12RS03/R2

HSU-18RS03/R2

HSU-22RS03/R2

H2SM-18HS03/R2

HSU-09HS03/R2(DB)

HSU-12HS03/R2(DB)

HSU-18HS03/R2(DB)

HSU-22HS03/R2(DB)

HSU-12HSB03/R2(DB)

- Please read this operation manual before using the air conditioner.

No.

Cautions

Disposal of the old air conditioner

Before disposing an old air conditioner that goes out of use, please make sure it's inoperative and safe. Unplug the air conditioner in order to avoid the risk of child entrapment.

It must be noticed that air conditioner system contains refrigerants, which require specialized waste disposal. The valuable materials contained in an air conditioner can be recycled. Contact your local waste disposal center for proper disposal of an old air conditioner and contact your local authority or your dealer if you have any question. Please ensure that the pipework of your air conditioner does not get damaged prior to being picked up by the relevant waste disposal center, and contribute to environmental awareness by insisting on an appropriate, anti-pollution method of disposal.

Disposal of the packaging of your new air conditioner

All the packaging materials employed in the package of your new air conditioner may be disposed without any danger to the environment.

The cardboard box may be broken or cut into smaller pieces and given to a waste paper disposal service. The wrapping bag made of polyethylene and the polyethylene foam pads contain no fluorochloric hydrocarbon.

All these valuable materials may be taken to a waste collecting center and used again after adequate recycling.

Consult your local authorities for the name and address of the waste materials collecting centers and waste paper disposal services nearest to your house.

Safety Instructions and Warnings

Before starting the air conditioner, read the information given in the User's Guide carefully. The User's Guide contains very important observations relating to the assembly, operation and maintenance of the air conditioner.

The manufacturer does not accept responsibility for any damages that may arise due to non-observation of the following instruction.

- Damaged air conditioners are not to be put into operation. In case of doubt, consult your supplier.
- Use of the air conditioner is to be carried out in strict compliance with the relative instructions set forth in the User's Guide.
- Installation shall be done by professional people, don't install unit by yourself.
- For the purpose of the safety, the air conditioner must be properly grounded in accordance with specifications.
- Always remember to unplug the air conditioner before opening inlet grill. Never unplug your air conditioner by pulling on the power cord. Always grip plug firmly and pull straight out from the outlet.
- All electrical repairs must be carried out by qualified electricians. Inadequate repairs may result in a major source of danger for the user of the air conditioner.
- Do not damage any parts of the air conditioner that carry refrigerant by piercing or perforating the air conditioner's tubes with sharp or pointed items, crushing or twisting any tubes, or scraping the coatings off the surfaces. If the refrigerant spurts out and gets into eyes, it may result in serious eye injuries.

Cautions

- Do not obstruct or cover the ventilation grille of the air conditioner. Do not put fingers or any other things into the inlet/outlet and swing louver.
- Do not allow children to play with the air conditioner. In no case should children be allowed to sit on the outdoor unit.

Specifications

- The refrigerating circuit is leak-proof.

The machine is adaptive in following situation

1. Applicable ambient temperature range:

Cooling	Indoor	Maximum:D.B/W.B 32°C/23°C Minimum:D.B/W.B 18°C/14°C
	Outdoor	Maximum:D.B/W.B 43°C/26°C Minimum:D.B 18°C
Heating	Indoor	Maximum:D.B 27°C Minimum:D.B 15°C
	Outdoor	Maximum:D.B/W.B 24°C/18°C Minimum:D.B/W.B -7°C/-8°C
	Outdoor (INVERTER)	Maximum:D.B/W.B 24°C/18°C Minimum:D.B/W.B -15°C

- If the power supply cord is damaged, it must be replaced by the manufacturer or its service agent or a similar qualified person.
- If the fuse of indoor unit on PC board is broken, please change it with the type of T. 3.15A/ 250V.
- The wiring method should be in line with the local wiring standard.
- After installation, the power plug should be easily reached.
- The waste battery should be disposed properly.
- The appliance is not intended for use by young children or infirm persons without supervision.
- Young children should be supervised to ensure that they do not play with the appliance.
- Please employ the proper power plug, which fit into the power supply cord.
- The power plug and connecting cable must have acquired the local attestation.
- For the unit H2SM-18HS03/R2
Through poor conditions of the electrical MAINS, shortly voltage drops can appear when starting the EQUIPMENT. This can influence other equipment (eg. Blinking of a lamp). If the MAINS-IMPEDANCE $Z_{max} < 0.325 \text{ OHM}$, such disturbances are not expected. (In case of need, you may contact your local supply authority for further information.)
- For the unit HSU-18RS03/R2
Through poor conditions of the electrical MAINS, shortly voltage drops can appear when starting the EQUIPMENT. This can influence other equipment (eg. Blinking of a lamp). If the MAINS-IMPEDANCE $Z_{max} < 1.088 \text{ OHM}$, such disturbances are not expected. (In case of need, you may contact your local supply authority for further information.)
- For the unit HSU-22RS03/R2
Through poor conditions of the electrical MAINS, shortly voltage drops can appear when starting the EQUIPMENT. This can influence other equipment (eg. Blinking of a lamp). If the MAINS-IMPEDANCE $Z_{max} < 0.094 \text{ OHM}$, such disturbances are not expected. (In case of need, you may contact your local supply authority for further information.)

Cautions

Safety Instruction

- Please read the following Safety Instructions carefully prior to use.
- The instructions are classified into two levels, WARNING and CAUTION according to the seriousness of possible risks and damages as follows. Compliance to the instructions are strictly required for safety use.





Installation

⚠ WARNING

Please call Sales/Service Shop for the Installation.
Do not attempt to install the air conditioner by yourself because improper works may cause electric shock, fire, water leakage.

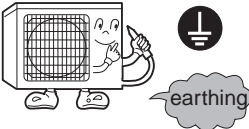
Installation in a inadequate place may cause accidents. Do not install in the following place.

⚠ CAUTION

<p>Connect the earth cable.</p> 	<p>Do not install in the place where there is any possibility of inflammable gas leakage around the unit.</p>  <p>PROHIBITION</p>	<p>Do not get the unit exposed to vapor or oil steam.</p>  <p>PROHIBITION</p>	<p>Check proper installation of the drainage securely</p>  <p>STRICT ENFORCEMENT</p>
---	--	--	---

Cautions

⚠ WARNING

When abnormality such as burnt-smell found, immediately stop the operation button and contact sales shop.

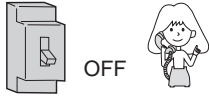

OFF



STRICT ENFORCEMENT

Use an exclusive power source with a circuit breaker

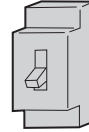

Connect power supply cord to the outlet completely



STRICT ENFORCEMENT

Use the proper voltage



STRICT ENFORCEMENT

Do not use power supply cord extended or connected in halfway



PROHIBITION

Do not use power supply cord in a bundle.

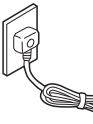

PROHIBITION

Take care not to damage the power supply cord.

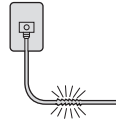

PROHIBITION

Do not insert objects into the air inlet or outlet.

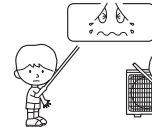

PROHIBITION

Do not start or stop the operation by disconnecting the power supply cord and so on.



PROHIBITION

Do not channel the air flow directly at people, especially at infants or the aged.



PROHIBITION

Do not try to repair or reconstruct by yourself.

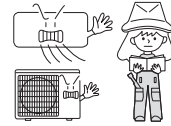

⚠ CAUTION

Do not use for the purpose of storage of food, art work, precise equipment, breeding, or cultivation.



PROHIBITION

Take fresh air occasionally especially when gas appliance is running at the same time.

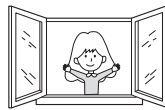

STRICT ENFORCEMENT

Do not operate the switch with wet hand.

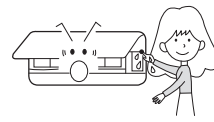

PROHIBITION

Do not install the unit near a fireplace or other heating apparatus.

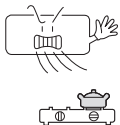

PROHIBITION

Check good condition of the installation stand

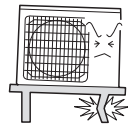

PROHIBITION

Do not pour water onto the unit for cleaning

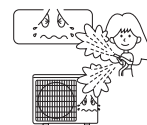

PROHIBITION

Do not place animals or plants in the direct path of the air flow

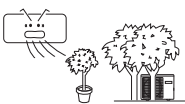

PROHIBITION

Do not place any objects on or climb on the unit.

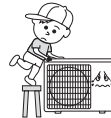

PROHIBITION

Do not place flower vase or water containers on the top of the unit.



PROHIBITION



Parts and Functions

Indoor unit

Display board

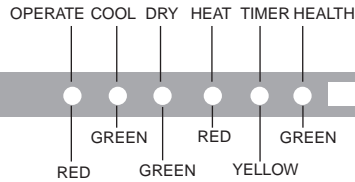

The conversion of pilot light's colors will be displayed as the figure under different operation models

Display board

Inlet

Anion generator (inside)

Air filter (inside)

Inlet grille

Vertical flap
(Use remote controller to adjust up and down air flow. Don't adjust it manually)

Horizontal louver
(adjust left and right air flow)

For multi-split type, the power plug is on the outdoor unit

Power plug

Outdoor unit

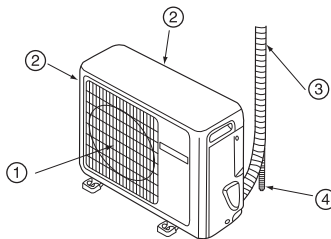

HSU-07RS03/R2
HSU-09RS03/R2

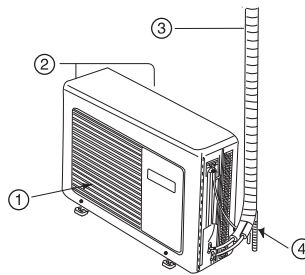

HSU-12RS03/R2

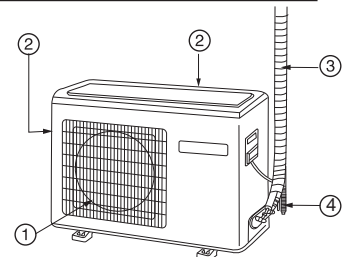

HSU-09HS03/R2(DB)
HSU-12HS03/R2(DB)
HSU-12HSB03/R2(DB)
HSU-18HS03/R2(DB)
HSU-18RS03/R2

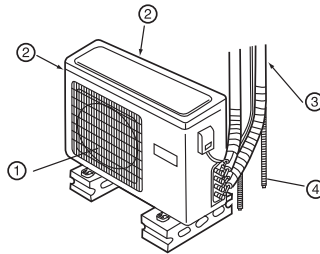

H2SM-18HS03/R2

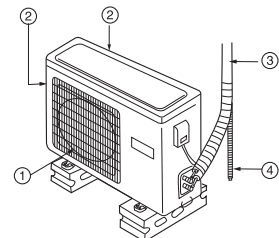

HSU-22RS03/R2
HSU-22HS03/R2(DB)

① OUTLET

② INLET

③ CONNECTING PIPING AND ELECTRICAL WIRING

④ DRAIN HOSE

Parts and Functions

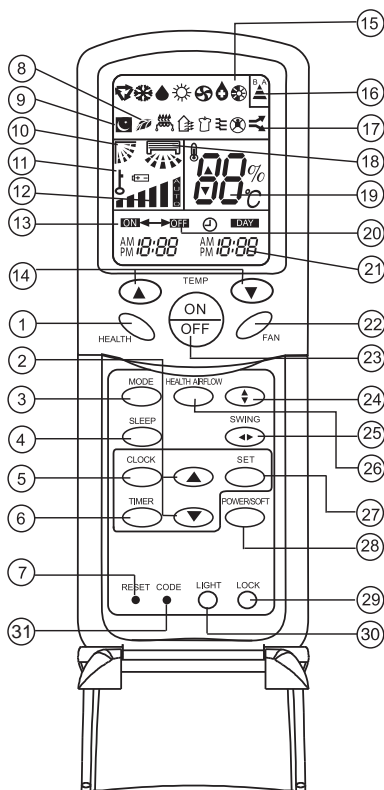

1. HEALTH button
Used to set healthy operation.
2. HOUR button
Used to set clock and timer setting.
3. MODE button
Used to select operation mode. AUTO, COOL, DRY, FAN, HEAT.
4. SLEEP button
Used to select sleep mode.
5. CLOCK button
Used to set correct time.
6. TIMER button
Used to select TIMER ON, TIMER OFF, TIMER ON-OFF.
7. RESET
When the remote controller appears abnormal, use a sharp pointed article to press this button to reset the remote controller normal.
8. HEALTH display
9. SLEEP display
10. SWING UP/DOWN display

11. LOCK display
12. FAN SPEED display



13. TIMER ON display
14. TEMP button
Used to select your desired temperature.
15. Operation mode display

Operation mode	AUTO	COOL	DRY	HEAT	FAN
Remote controller					

16. SINGAL SENDING display
17. POWER/SOFT display
18. Left/right air flow display
19. TEMP display
Remote controller: to display the TEMP. setting.
20. TIMER OFF display
21. CLOCK display
22. FAN button
Used to select fan speed: LOW, MED, HI, AUTO.
23. ON/OFF button
Used for unit start and stop.
24. SWING UP/DOWN button
Used to select up or down air sending direction.
25. SWING LEFT/RIGHT button
Used to select left or right air flow.
26. HEALTH AIRFLOW button
Used to set the health airflow mode.
27. SET button
Used to confirm timer and clock settings.
28. POWER/SOFT button
29. LOCK
Used to lock buttons and LCD display. If pressed, the other buttons will be disabled and the lock condition display appears. Press it once again, lock will be canceled and lock condition display disappears.
30. LIGHT button
Colorful display bar of the controlling indoor machine is on and extinguished.
31. CODE
Used to select CODE A or B with a press, A or B will be displayed on LCD. Please select A without special explanation.

NOTE: (1)The following functions and related displays are not available: (30) (31)
(2) Cooling only unit do not have functions and displays related with heating.

Parts and Functions

■ Clock Set

When unit is started for the first time and after replacing batteries in remote controller, clock should be adjusted as follows:

1. Press CLOCK button, "AM" or "PM" flashes.
2. Press \triangle or ∇ to set correct time. Each press will increase or decrease 1 min. If the button is kept depressed, time will change quickly.
3. After time setting is confirmed, press SET, "AM" or "PM" stop flashing, while clock starts working.

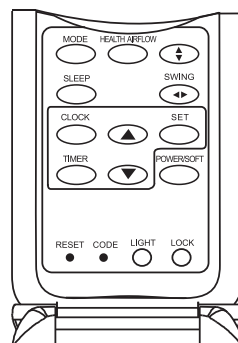

■ Remote controller's operation

- When in use, put the signal transmission head directly to the receiver hole on the indoor unit.
- The distance between the signal transmission head and the receiver hole should be within 7 m without any obstacle as well.
- Don't throw or knock the remoter controller.
- When electronic-started type fluorescent lamp or change-over type fluorescent lamp or wireless telephone is installed in the room, the receiver is apt to be disturbed in receiving the signals, so the distance to the indoor unit should be shorter.

■ Loading of the battery

Load the batteries as illustrated right
2 R-03 (7#) batteries

Remove the battery cover:

Slightly press "≡" area and push down the cover as illustrated.

Load the battery:

Be sure that the loading is in line with the "+" / "-" request as illustrated on the bottom of the case.

Put on the cover again.

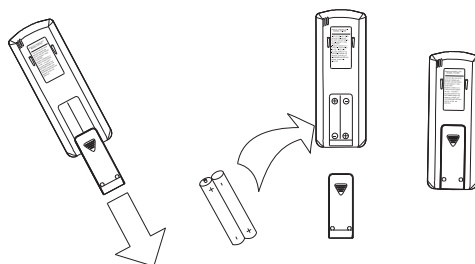

Confirmation indicator:

After pressing power ON/OFF, if no display, reload the batteries.

Note:

- Full display or unclear display during operation indicates the batteries have been used up. Please change batteries.
- Used two new same-typed batteries when loading.
- If the remote controller can't run normally during operation, please remove the batteries and reload several minutes later.

Hint:

Remove the batteries in case unit won't be in usage for a long period. If there are any display after taking-out, just need to press reset key.

Operation

Health Operation

Remote controller

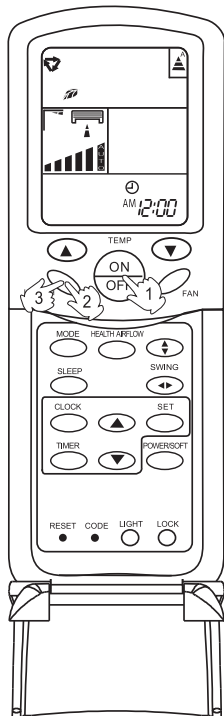

1. Unit start

Link with electronic power.

Press ON/OFF on the remote controller, unit starts.

The liquid crystal will display the working state of last time (Except Timer, Sleep, Power/Soft and Health airflow).

Then set up the comfortable working state.

2. Select operation mode

Press HEALTH button. For each press,  is displayed.

The pilot light of healthy process on the display board is on, hence healthy process begins.

When indoor fan motor is running, it has healthy process function. (It's available under any mode)

3. Unit stop

Press HEALTH button, the healthy function stops.

The pilot light of healthy process on the display board is extinguished.

BRIEF INTRODUCTION TO HEALTH OPERATION

The anion generator in the air conditioner can generate a lot of anion to effectively balance the quantity of positive and negative ions in the air and also to kill

bacteria and speed up the dust sediment in the room and finally clean the air in the room.

Note

When the fan in the indoor unit does not work, the health lamp lights up, but the anion generator does not release anion.

Operation

Auto Operation

Remote controller

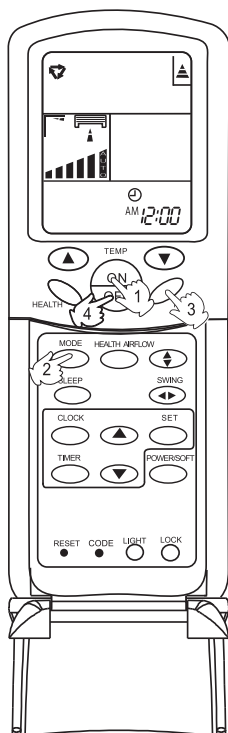

1. Unit start

Link with electronic power.

Press ON/OFF on the remote controller, unit starts.

The liquid crystal will display the working state of last time (Except Timer, Sleep, Power/Soft and Health airflow).

2. Select operation mode

Press MODE button. For each press, operation mode changes as follows:

Remote controller:



Then Select Auto operation

3. Fan speed selection

Press FAN button. For each press, fan speed changes as follows:

Remote controller:



Air conditioner is running under displayed fan speed
When FAN is set to AUTO, the air conditioner automatically adjusts the fan speed according to room temperature.

4. Unit stop

Press ON/OFF button, the unit stops.

About Auto Operation

Under the mode of auto operation, air conditioner will automatically select Cool or Heat operation according to room temperature.

Operation

Cool Operation

Remote controller

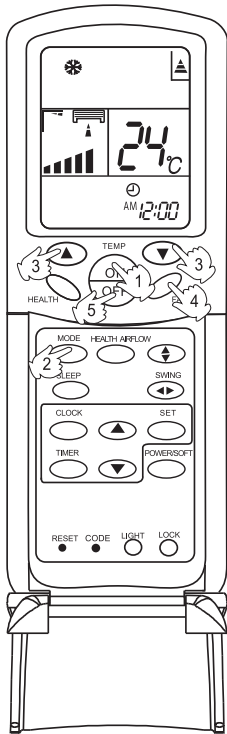

1. Unit start

Link with electronic power.

Press ON/OFF on the remote controller, unit starts.

The liquid crystal will display the working state of last time (Except Timer, Sleep, Power/Soft and Health airflow).

2. Select operation mode

Press MODE button. For each press, operation mode changes as follows:

Remote controller:



Then Select COOL operation

3. Select temp. setting

Press TEMP. button

△ Every time the button is pressed, temp.setting increase 1°C, if kept depressed, it will increase rapidly

▽ Every time the button is pressed, temp.setting increase 1°C, if kept depressed, it will decrease rapidly

Select a desired temperature.

4. Fan speed selection

Press FAN button. For each press, fan speed changes as follows:

Remote controller:



Air conditioner is running under displayed fan speed

When FAN is set to AUTO, the air conditioner automatically adjusts the fan speed according to room temperature.

5. Unit stop

Press ON/OFF button, the unit stops.

Operation

Dry Operation

Remote controller

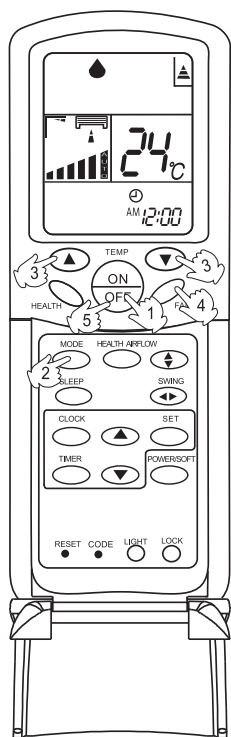

1. Unit start

Link with electronic power.

Press ON/OFF on the remote controller, unit starts.

The liquid crystal will display the working state of last time (Except Timer, Sleep, Power/Soft and Health airflow).

2. Select operation mode

Press MODE button. For each press, operation mode changes as follows:

Remote controller:



Then Select DRY operation

3. Select temp. setting

Press TEMP. button

△ Every time the button is pressed, temp. setting increase 1°C, if kept depressed, it will increase rapidly

▽ Every time the button is pressed, temp. setting decrease 1°C, if kept depressed, it will decrease rapidly

Select a desired temperature.

4. Fan speed selection

Press FAN button. For each press, fan speed changes as follows:

Remote controller:



Air conditioner is running under displayed fan speed
In DRY mode, when room temperature becomes 2°C higher than temp. setting, unit will run intermittently at LOW speed regardless of FAN setting.

5. Unit stop

Press ON/OFF button, the unit stops.

COOL operation starts when room temp. is higher than temp. setting.

Ultra-low air flow

Temp. setting + 2°C
Temp. setting

On reaching temp. setting + 2°C unit will run in mild DRY mode.

Operation

Fan Operation

Remote controller

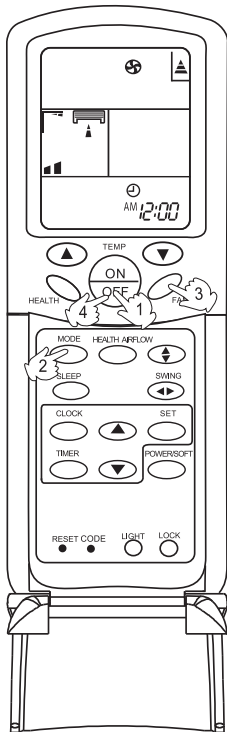

1. Unit start

Link with electronic power.

Press ON/OFF on the remote controller, unit starts.

The liquid crystal will display the working state of last time (Except Timer, Sleep, Power/Soft and Health airflow).

2. Select operation mode

Press MODE button. For each press, operation mode changes as follows:

Remote controller:



Then Select FAN operation

3. Fan speed selection

Press FAN button. For each press, fan speed changes as follows:

Remote controller:



4. Unit stop

Press ON/OFF button, the unit stops.

About FAN operation

In FAN operation mode, the unit will not operate in COOL or HEAT mode but only in FAN mode, AUTO is not available in FAN mode. And temp. setting is disabled. In FAN mode, SLEEP operation is not available.

Operation

Heat Operation

Remote controller

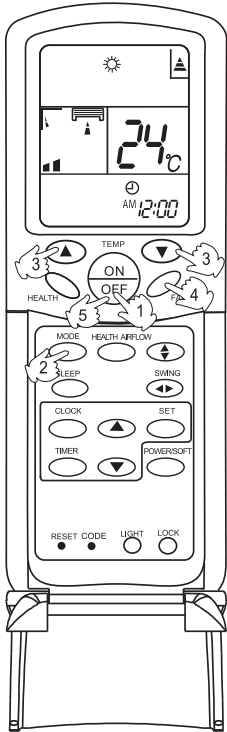

1. Unit start

Link with electronic power.

Press ON/OFF on the remote controller, unit starts.

The liquid crystal will display the working state of last time (Except Timer, Sleep, Power/Soft and Health airflow).

2. Select operation mode

Press MODE button. For each press, operation mode changes as follows:

Remote controller:



Then **Select HEAT operation**

3. Select temp. setting

Press TEMP. button

△ Every time the button is pressed, temp. setting increase 1°C, if kept depressed, it will increase rapidly

▽ Every time the button is pressed, temp. setting increase 1°C, if kept depressed, it will decrease rapidly

Select a desired temperature.

4. Fan speed selection

Press FAN button. For each press, fan speed changes as follows:

Remote controller:



Air conditioner is running under displayed fan speed IN HEAT mode, warm air will blow out after a short period of the time due to cold-draft prevention function.

When FAN is set to AUTO, the air conditioner automatically adjusts the fan speed according to room temperature.

5. Unit stop

Press ON/OFF button, the unit stops.

Operation

Air Flow Direction Adjustment

1. Status display of air sending direction

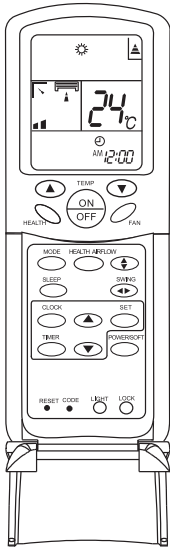

Vertical flap

- Pos.1
- Pos.2
- Pos.3
- Pos.4
- Pos.5
- Pos.6

Horizontal louvers

- Pos.1
- Pos.2
- Pos.3
- Pos.4
- Pos.5
- Pos.6
- Pos.7
- Pos.8

2. Up and down air flow direction

For each press of button, air flow direction on remote controller displays as follows according to different operation modes:

COOL/DRY/FAN:

remote controller:

HEAT:

remote controller:

AUTO:

remote controller:

The vertical flap will swing according to the above positions

3. Left and right air flow direction

For each press of button, remote controller displays as follows :

remote controller:

The horizontal louvers will swing according to the above positions.

Note: When restart after remote turning off, the remote controller will automatically memorize the previous set swing position.

Operation

Sleep Operation

Before going to bed, you can simply press the SLEEP button and unit will operate in SLEEP mode and bring you a sound sleep.

Use of SLEEP function

After the unit starts, set the operation status, then press SLEEP button before which the clock must be adjusted and time being set.

Operation Mode

1. In COOL, DRY mode

1 hours after SLEEP mode starts, temp. will become 1°C higher than temp. setting. After another 1 hours, temp. rises by 1°C further. The unit will run for further 6 hours then stops. Temp. is higher than temp. setting so that room temperature won't be too low for your sleep.

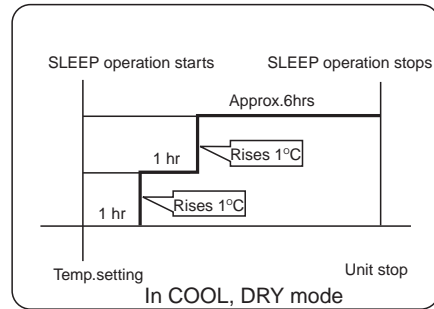

2. In HEAT mode

1 hours after SLEEP mode starts, temp will become 2 °C lower than temp. setting. After another 1 hours, temp decrease by 2 °C further. After more another 3 hours, temp. rises by 1°C further. The unit will run for further 3 hours then stops. Temp. is lower than temp. setting so that room temperature won't be too high for your sleep.

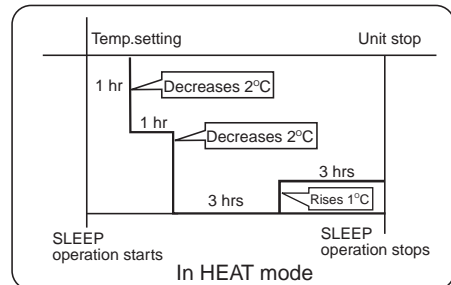

3. In AUTO mode

The unit operates in corresponding sleep mode adapted to the automatically selected operation mode.

4. In FAN mode

It has no SLEEP function.

Remote Controller

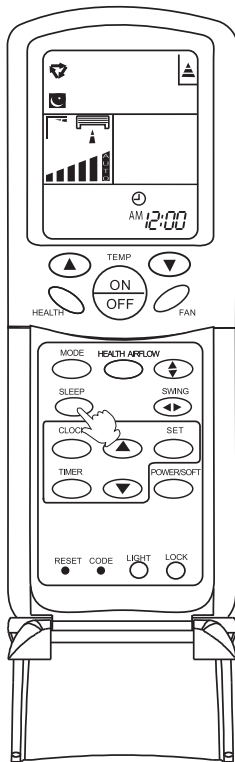

Note

The sleeping hours lasts 8 hours and couldn't be adjusted. When timing on function is set, the sleeping function can't be set up. After the sleeping function is set up, if user resets timing on function, the sleeping function will be cancelled; the machine will be in the state of timing-on. If the sleeping function and timing-on function are set up at the same time, no matter which one is operated earlier, the machine will be off automatically, and the other function will also be cancelled.

Operation

Timer On/Off Operation

Remote Controller

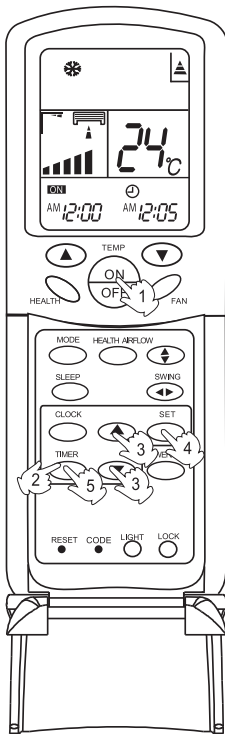

Set clock correctly before starting TIMER operation.

1. After unit starts, select your desired operation mode
Operation mode will be displayed on LCD.

2. Timer mode selection

Press TIMER button to change TIMER mode. Every time the button is pressed, display changes as follows:

Remote controller:



Then select your desired TIMER mode (TIMER ON or TIMER OFF). " ON "or " OFF "will flash.

3. Time setting

Press HOUR Δ / ∇ button.

Δ Every time the button is pressed, time setting increases 1 min , if kept depressed, it will increase rapidly.

∇ Every time the button is pressed, time setting decreases 1 min, if kept depressed, it will decrease rapidly.

It can be adjusted within 24 hours.

4. Confirming your setting

After setting correct time, press SET button to confirm
" ON "or" OFF "on the remote controller stops flashing.

Time displayed: Unit starts or stops at x hour x min.
(TIMER ON or TIMER OFF).

5. Cancel TIMER mode

Just press TIMER button several times until TIMER mode disappears.

Hints:

After replacing batteries or a power failure happens, time setting should be reset.
Remote controller possesses memory function, when use TIMER mode next time, just press SET button after mode selecting if time setting is the same as previous one.

Operation

Timer On-Off Operation

Remote Controller

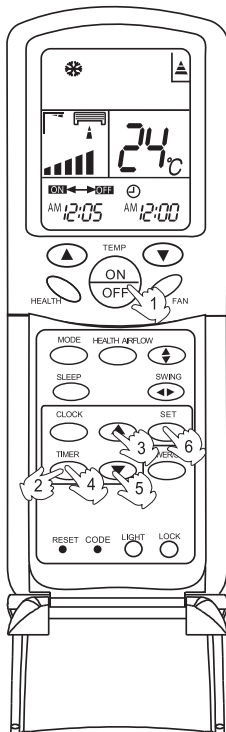

Set clock correctly before starting TIMER operation.

1. After unit starts, select your desired operation mode
Operation mode will be displayed on LCD.

2. Timer mode selection

Press TIMER button to change TIMER mode. Every time the button is pressed, display changes as follows:

Remote controller:



Then select your desired TIMER mode (TIMER ON - OFF).

" ON " will flash.

3. Time setting

Press HOUR Δ / ∇ button.

Δ Every time the button is pressed, time setting increases 1 min , if kept depressed, it will increase rapidly.

Every time the button is pressed, time setting

∇ decreases 1 min, if kept depressed, it will decrease rapidly. It can be adjusted within 24 hours.

4. Timer confirming for TIMER ON

After setting correct time, press TIMER button to confirm

" ON " on the remote controller stops flashing.

" OFF " starts flashing.

Time displayed: Unit starts or stops at x hour x min.

5. Time setting for TIMER OFF

Just press HOUR button ,follow the same procedure in

"Time setting for TIMER ON"

6. Time confirming for TIMER OFF

After time setting,press SET button to confirm.

" OFF " on the remote controller stops blinking.

Time displayed:Unit stops at x hour x min.

To cancel TIMER mode

Just press TIMER button several times until TIMER mode disappears.

According to the Time setting sequence of TIMER ON or TIMER OFF, either Start-Stop or Stop-Start can be achieved.

Operation

POWER/SOFT Operation

POWER Operation

When you need rapid heating or cooling, you can use this function.

Selecting of POWER operation

Press POWER/SOFT button. Every time the button is pressed, display changes as follows:



Stop the display at " ⚡ ".

In POWER operation status:

In HEAT or COOL mode, fan speed automatically runs in HI mode for 15 min then returns to original status setting.

To cancel POWER operation

Press POWER/SOFT button twice ,POWER/SOFT disappears.

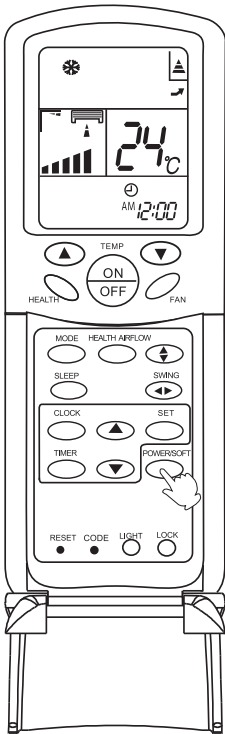

SOFT Operation

You can use this function when silence is needed for rest or reading.

Selecting of SOFT operation

Press POWER/SOFT button. Every time the button is pressed, display changes as follows:



Stop the display at " S ".

In SOFT operation mode, fan speed automatically takes "LOW"

To cancel POWER operation

Press POWER/SOFT button twice ,POWER/SOFT disappears.

Hints:

During POWER operation, in rapid HEAT or COOL mode, the room will show inhomogeneous temperature distribution.

Long period SOFT operation will cause effect of not too cool or not too warm.

Operation

Health airflow Operation

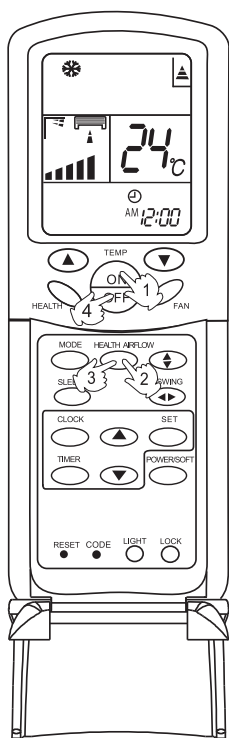

1. Press ON/OFF to starting

The liquid crystal will display the working state of last time (Except timer, sleeping, power/soft and health airflow).
Setting the comfort work conditions.

2. The setting of health airflow function

1). Press the button of health airflow,  appears on the display. The nether inlet and outlet grills of the air conditioner are closed and the airflow is blown horizontally from the above inlet and outlet grills. Avoid the strong airflow blows direct to the body.

2). Press the button of health airflow again,  appears on the display. The above inlet and outlet grills of the air conditioner are closed and the airflow is blown vertically from the nether inlet and outlet grills. Avoid the strong airflow blows direct to the body.

3. The cancel of the health airflow function

Press the button of health airflow again, both the inlet and outlet grills of the air conditioner are opened, and the unit goes on working under the condition before the setting of health airflow function.

After stopping, the outlet grille will close automatically.

Notice: Cannot pull direct the outlet grille by hand. Otherwise, the grille will run incorrectly. If the grille is not run correctly, stop for a minute and then start, adjusting by remote controller.

Note:

1 .After setting the health airflow function, the position of inlet and outlet grills is fixed.

2. In heating, it is better to select the  mode.

3. In cooling, it is better to select the  mode.

4. In cooling and dry, using the air conditioner for a long time under the high air humidity, a phenomenon falling drips of water occurs at the outlet grille .

5. Select the appropriate fan direction according to the actual conditions.

Operation

Emergency and Test Operation

Emergency operation:

- Use this operation only when the remote controller is defective or lost.
- When the emergency operation switch is pressed, the "Pi" sound is heard once, which means the start of this operation.
- In this operation, the system automatically selects the operation modes, cooling or heating, according to the room temperature.
- When machine is running in emergency, the set value of temperature and wind speed couldn't be altered; meanwhile, it can't operate for dehumidifying or under timing mode.

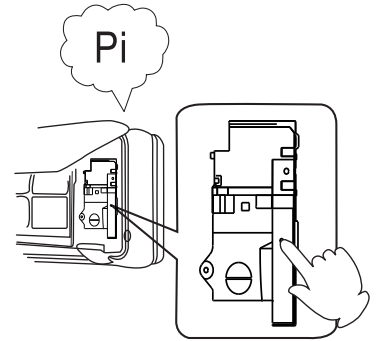

Test operation:

Test operation switch is the same as emergency switch.

- Use this switch in the test operation when the room temperature is below 16°C, do not use it in the normal operation.
- Continue to press the test operation switch for more than 5 seconds. After you hear the "Pi" sound twice, release your finger from the switch: the cooling operation starts with the air flow speed "Hi".

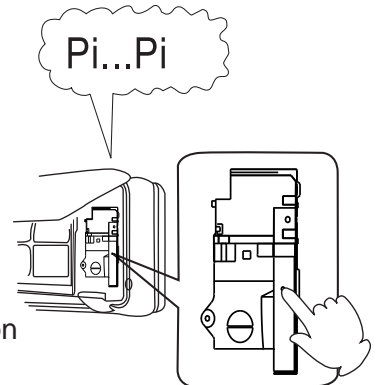

Removal of the restriction of emergency or test operation

- Press the emergency operation switch once more, or manipulate through the remote controller; the "Pi" sound, the emergency or test operation is terminated.
- When the remote controller is manipulated, it gets the system back to the normal operation mode.

Maintenance

For Smart Use of The Air Conditioner

Setting of proper room temperature

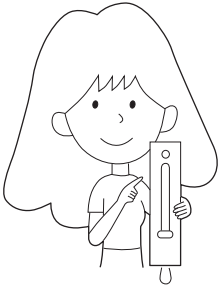

Proper temperature

Do not block the air inlet or outlet

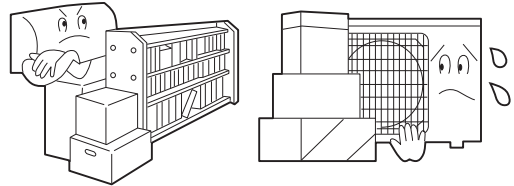

Close doors and windows during operation

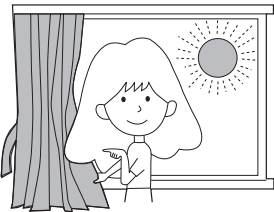

During cooling operation, prevent the penetration of direct sunlight with curtain or blind.

Use the timer effectively

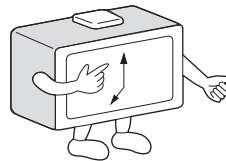
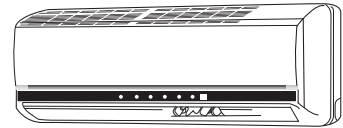

If the unit is not to be used for a long time, turn off the power supply main switch.

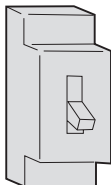

OFF

Use the louvers effectively

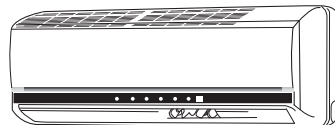

Maintenance

For Smart Use of The Air Conditioner

⚠ WARNING

Before maintenance, be sure to turn off the system and the circuit breaker.

Remote Controller

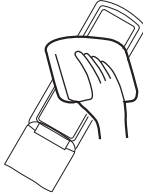

Do not use water, wipe the controller with a dry cloth. Do not use glass cleaner or chemical cloth.

Indoor Body

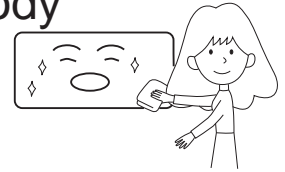

Wipe the air conditioner by using a soft and dry cloth. For serious stains, use a neutral detergent diluted with water. Wring the water out of the cloth before wiping, then wipe off the detergent completely.

Do not use the following for cleaning



Gasoline, benzene, thinner or cleanser may damage the coating of the unit.



Hot water over 40°C (104°F) may cause discoloring or deformation.

Air Filter cleaning

1 Open the inlet grille by pulling it upward.

2 Remove the filter.

Push up the filter's center tab slightly until it is released from the stopper, and remove the filter downward.

3 Clean the filter.

Use a vacuum cleaner to remove dust, or wash the filter with water. After washing, dry the filter completely in the shade.

4 Attach the filter.

Attach the filter correctly so that the "FRONT" indication is facing to the front. Make sure that the filter is completely fixed behind the stopper. If the right and left filters are not attached correctly, that may cause defects.

5 Close the inlet grille.

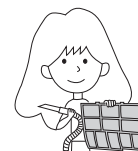
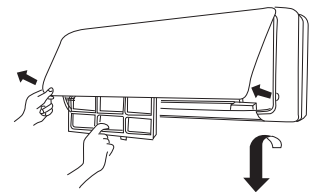

Once every two weeks

Maintenance

Replacement of Air Purifying Filter

1. Open the Inlet Grille

Open the inlet grille by pushing each ends of the inlet grille upward.(use thumbs to push up)

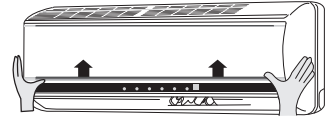

2. Detach the standard air filter

Slide the knob slightly upward to release the filter, then withdraw it.

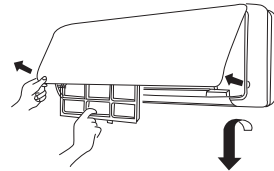

3. Detach old Air Purifying Filter

4. Attach old Air Purifying Filter

Put air purifying filter appliances into the right and left filter frames .



Detach old Air Purifying Filter

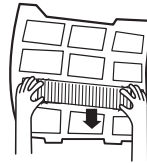

5. Attach the standard air filter

(Necessary installation)

6. Close the Inlet Grille

Close the Grille surely

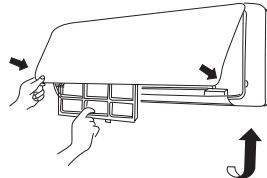

NOTE:

- The air purifying filter of the bacteria-killing medium and the electrostatic air purifying filter accessories with machine will be used based on real situation.
- The bacteria-killing medium air purifying filter is available for a long time and needn't to be changed. But it must be noticed to use the vacuum cleaner frequently to adsorb the dusts covering the purifying filter lest the covering dusts effect the function of the bacteria-killing medium air purifying filter. (It is strictly prohibited for the bacteria-killing medium air purifying filter to be washed)
- The green aspect of the bacteria-killing medium air purifying filter will face outside, the white aspect will face to the machine. and the white side of the electrostatic air purifying filter will face outside.

Maintenance

To Keep Your Air conditioner in Good Condition after Season.

1 Operate in cooling mode for 2-3 hours.

To prevent breeding mold or bad smell, be sure to operate at the designated temperature or 30°C, cooling mode and High speed fan mode for 2-3 hours.

2 Put off the power supply cord.

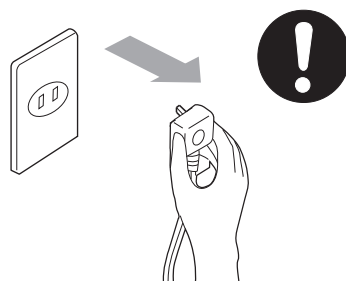

3 Cleaning the body.

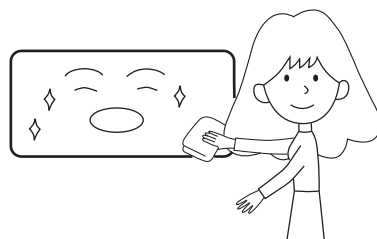

4 Take out the batteries from the wireless remote controller.

Maintenance

Before Setting in High season

1 Cleaning the standard air filter.

Operation without filter may cause troubles. Be sure to attach both right and left filters prior to the operation. Each of them are of different shapes.

2 Connecting the cable.

⚠ Caution

- Incomplete earthing may cause an electric shock.

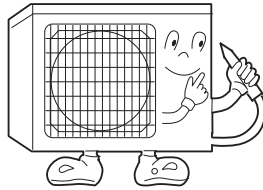

EARTHING

3 Do not block the air inlet or outlet.

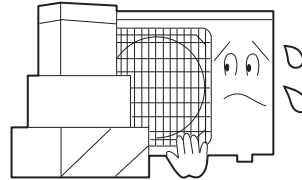
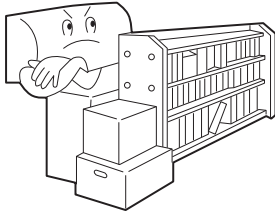

4 Plug-in

⚠ Caution



- After brush away dust at the plug, insert the plug of the power supply cord into the outlet completely. In case of using exclusive circuit breaker, switch on the circuit breaker.



NO WET HAND

Trouble shooting

Before asking for service, check the following first.

	Phenomenon	Cause or check points
Normal Performance inspection	<p>The system does not restart immediately.</p> 	<ul style="list-style-type: none"> • When unit is stopped, it won't restart immediately until 3 minutes have elapsed to protect the system. • When the electric plug is pulled out and reinserted, the protection circuit will work for 3 minutes to protect the air conditioner.
	<p>Noise is heard:</p> 	<ul style="list-style-type: none"> • During unit operation or at stop, a swishing or gurgling noise may be heard. At first 2-3 minutes after unit start, this noise is more noticeable. (This noise is generated by refrigerant flowing in the system.) • During unit operation, a cracking noise may be heard. This noise is generated by the casing expanding or shrinking because of temperature changes. • Should there be a big noise from air flow in unit operation, air filter may be too dirty.
	<p>Smells are generated.</p>	<ul style="list-style-type: none"> • This is because the system circulates smells from the interior air such as the smell of furniture, cigarettes.
	<p>Mist or steam are blown out.</p>	<ul style="list-style-type: none"> • During COOL or DRY operation, indoor unit may blow out mist. This is due to the sudden cooling of indoor air.
Multiple check	<p>Does not work at all.</p>	<ul style="list-style-type: none"> • Is power plug inserted? • Is there a power failure? • Is fuse blown out?
	<p>Poor cooling</p> 	<ul style="list-style-type: none"> • Is the air filter dirty? Normally it should be cleaned every 15 days. • Are there any obstacles before inlet and outlet? • Is temperature set correctly? • Are there some doors or windows left open? • Is there any direct sunlight through the window during the cooling operation?(Use curtain) • Are there too much heat sources or too many people in the room during cooling operation?